

Article number: 0101178
 Description: Retaining ring A 260 DIN 471
 Spring steel
 Note: Fitted with ZGA pilers

Measures

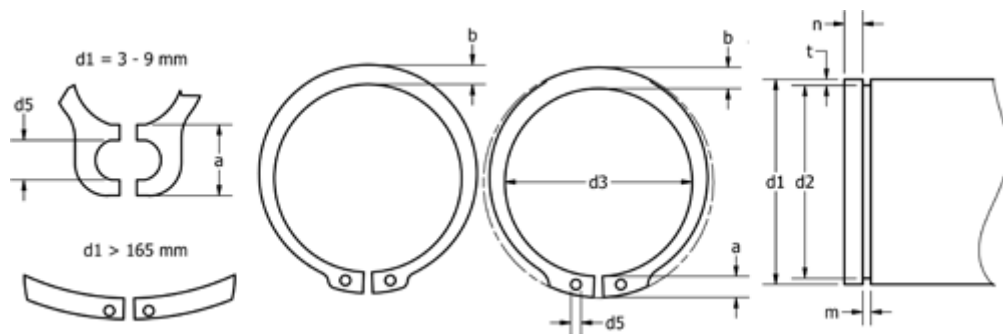

a max	= 16.2	FN kN	= 535.0	s	= 5.00
AN mm ²	= 3215.0	FRg kN	= 54.60	t	= 4.00
b	= 16.0	FR kN	= 540.00	tol	= -0.81
d1	= 260	g	= 6.0	tol	= -0.12
d2	= 252.0	K kN-mm	= 1250.00	tol	= +0,72-1,70
d3	= 245.0	m min	= 5.15	Tong	= ZGA-6
d5 min	= 5.0	n abl x 1000	= 1.0	Weight kg/1000	= 355.000
Description	= A260	Nominal drive	= 12.0		